

# Dell PowerEdge M1000e, M915, M910, M820, M710HD, M710, M620, M610x, M610, M520, and M420 Getting Started Guide

**Regulatory Model: BMX01, DWHH, HHB, FHB, and QHB**  
**Regulatory Type: DWHH Series, HHB Series, FHB Series, and QHB**  
**Series**



# Notes, Cautions, and Warnings



**NOTE:** A NOTE indicates important information that helps you make better use of your computer.



**CAUTION:** A CAUTION indicates either potential damage to hardware or loss of data and tells you how to avoid the problem.



**WARNING:** A WARNING indicates a potential for property damage, personal injury, or death.

**Information in this publication is subject to change without notice.**

**© 2012 Dell Inc. All rights reserved.**

Reproduction of these materials in any manner whatsoever without the written permission of Dell Inc. is strictly forbidden.

Trademarks used in this text: Dell™, the Dell logo, Dell Precision™, OptiPlex™, Latitude™, PowerEdge™, PowerVault™, PowerConnect™, OpenManage™, EqualLogic™, Compellent™, KACE™, FlexAddress™, Force10™ and Vostro™ are trademarks of Dell Inc. Intel®, Pentium®, Xeon®, Core® and Celeron® are registered trademarks of Intel Corporation in the U.S. and other countries. AMD® is a registered trademark and AMD Opteron™, AMD Phenom™ and AMD Sempron™ are trademarks of Advanced Micro Devices, Inc. Microsoft®, Windows®, Windows Server®, Internet Explorer®, MS-DOS®, Windows Vista® and Active Directory® are either trademarks or registered trademarks of Microsoft Corporation in the United States and/or other countries. Red Hat® and Red Hat® Enterprise Linux® are registered trademarks of Red Hat, Inc. in the United States and/or other countries. Novell® and SUSE® are registered trademarks of Novell Inc. in the United States and other countries. Oracle® is a registered trademark of Oracle Corporation and/or its affiliates. Citrix®, Xen®, XenServer® and XenMotion® are either registered trademarks or trademarks of Citrix Systems, Inc. in the United States and/or other countries. VMware®, Virtual SMP®, vMotion®, vCenter® and vSphere® are registered trademarks or trademarks of VMware, Inc. in the United States or other countries. IBM® is a registered trademark of International Business Machines Corporation.

Other trademarks and trade names may be used in this publication to refer to either the entities claiming the marks and names or their products. Dell Inc. disclaims any proprietary interest in trademarks and trade names other than its own.

2012 - 03

Rev. A00

# Installation And Configuration

 **WARNING:** Before performing the following procedure, review the safety instructions that came with the blade server or enclosure.

## Unpacking The System

Unpack your blade server or enclosure and identify each item.

## Installing The Rails And Enclosure

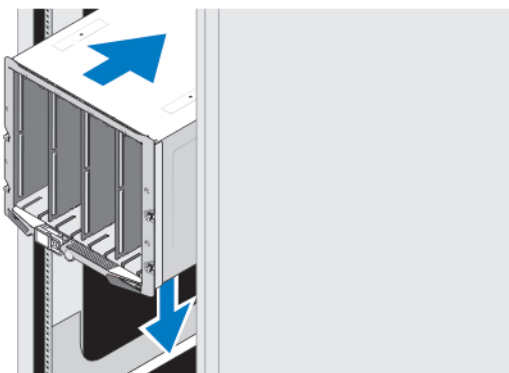

**Figure 1. Installing the Enclosure in the Rack**

Assemble the rails and install the enclosure in the rack, following the safety instructions and the rack installation instructions provided with the enclosure.

## Installing A Sleeve In The Enclosure

 **NOTE:** This procedure applies only to PowerEdge M420.

A sleeve includes up to four quarter-height blades to function as a system. Depending on your order, the sleeve may ship with the blades preinstalled.

 **CAUTION:** Exercise utmost care when installing or removing the sleeve to prevent damage to the internal components. To ensure protection for the electronic components inside, follow the Electrostatic Discharge (ESD) guidelines.



**Figure 2. Installing a Sleeve**

- ✎ **NOTE:** Before you install or remove a sleeve from the enclosure, ensure that the top slot of the sleeve (Blade a) is empty. You can install a blade in the top slot (Blade a) after you install the sleeve in the enclosure.

Remove the orange cover from the sleeve handle. Slide the sleeve into the enclosure and lift the sleeve handle to the top position to secure the sleeve in the enclosure.

- ✎ **NOTE:** To ensure optimal thermal performance, do not replace the cover on the sleeve handle after the sleeve is installed in the enclosure. Reinstall the cover only if the sleeve is not installed in the enclosure.

### Installing A Quarter-Height Blade In A Sleeve

- ⚠ **CAUTION:** Install a blade blank in all empty blade slots to maintain proper thermal conditions.

Slide the blade into the sleeve and rotate the blade handle upward to secure the blade in the sleeve.

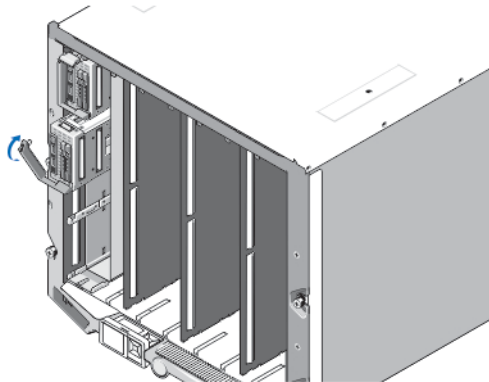

**Figure 3. Installing a Quarter-Height Blade**

### Installing A Full Or Half-Height Blade

- ⚠ **CAUTION:** Install a blade blank in all empty blade slots to maintain proper thermal conditions.

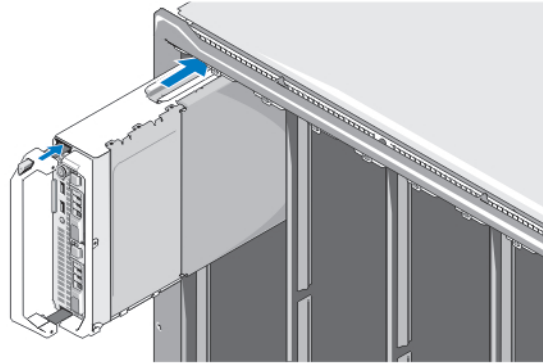
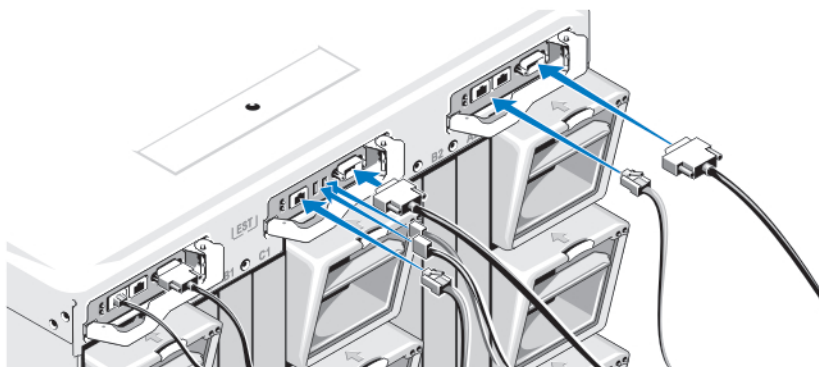

**Figure 4. Installing a Half-Height Blade**

**NOTE:** The above figure shows installation of a half-height blade. The procedure for installing a full-height blade is identical to installing a half-height blade.

Beginning at the top, slide the blades into the enclosure from left to right. When the blade is securely installed, the blade handle returns to the closed position.

## Connecting The CMC And iKVM Modules

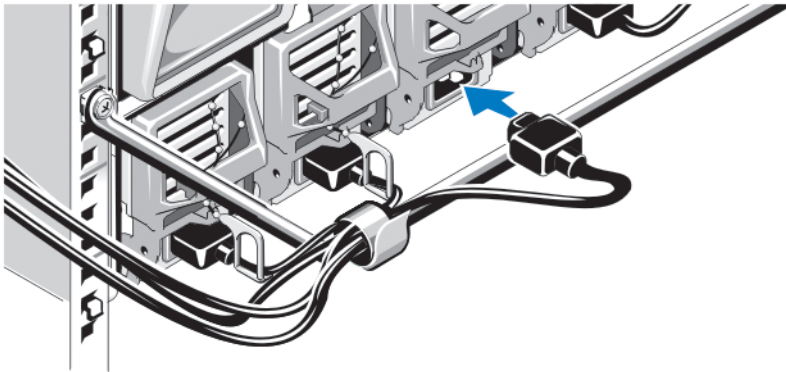

**Figure 5. Connecting the Modules**

Connect the serial cable and network cable(s) from the management system to the CMC module. If a second optional CMC module is installed, connect it as well.



Connect the keyboard, mouse, and monitor to the optional iKVM module.

## Connecting The System To Power



**Figure 6. Connecting Power to the System**

Connect the system's power cables to the system power supplies.

-  **CAUTION:** To prevent the power cables from being disconnected accidentally, use the plastic clip on each power supply to secure the power cable to the power supply, and use the strap to secure the power cable to the strain-relief bar.
-  **CAUTION:** Do not plug the power cables directly into a power outlet; you must use a PDU. For optimal system functionality, a minimum of three power supplies are required.

Plug the other end of the power cables into a power distribution unit (PDU).

-  **NOTE:** The power supply units must have the same maximum output power.

## Turning On The Enclosure

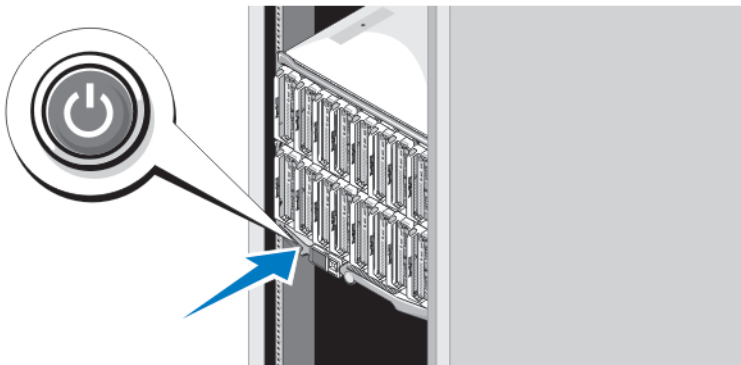

**Figure 7. Enclosure Power Button**

Press the power button on the enclosure. The power indicator should light.

## Turning On The Blades

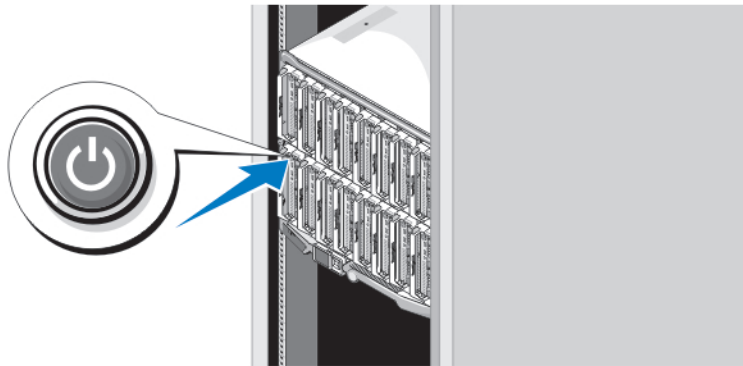

**Figure 8. Turning on a Blade**

Press the power button on each blade, or power on the blades using the systems management software.

## Complete The Operating System Setup

If you purchased a preinstalled operating system, see the documentation associated with the operating system. To install an operating system for the first time, see the installation and configuration documentation for your operating system. Be sure the operating system is installed before installing hardware or software not purchased with the system.

 **NOTE:** See [dell.com/ossupport](http://dell.com/ossupport) for the latest information on supported operating systems.

## Dell Software License Agreement

Before using your system, read the Dell Software License Agreement that came with your system. You must consider any media of Dell-installed software as BACKUP copies of the software installed on your system's hard drive. If you do not accept the terms of the agreement, call the customer assistance telephone number. For customers in the United States, call 800-WWW-DELL (800-999-3355). For customers outside the United States, visit [support.dell.com](http://support.dell.com) and select your country or region from the top of the page.

## Other Information You May Need

 **WARNING:** See the safety and regulatory information that shipped with your system. Warranty information may be included within this document or as a separate document.

- The Owner's Manual provides information about system features and describes how to troubleshoot the system and install or replace system components. This document is available online at [support.dell.com/manuals](http://support.dell.com/manuals).
- For the Owner's Manuals and Installation Guides for Dell EqualLogic hardware, go to [support.equallogic.com](http://support.equallogic.com).
- The rack documentation included with your rack solution describes how to install your system into a rack, if required.
- Any media that ships with your system that provides documentation and tools for configuring and managing your system, including those pertaining to the operating system, system management software, system updates, and system components that you purchased with your system.

 **NOTE:** Always check for updates on [support.dell.com/manuals](http://support.dell.com/manuals) and read the updates first because they often supersede information in other documents.

## Obtaining Technical Assistance

If you do not understand a procedure in this guide or if the system does not perform as expected, see your *Owner's Manual*. Dell offers comprehensive hardware training and certification. See [dell.com/training](http://dell.com/training) for more information. This service may not be offered in all locations.

## NOM Information

The following information is provided on the device described in this document in compliance with the requirements of the official Mexican standards (NOM):

Importer: Dell Inc. de México, S.A. de C.V.  
Paseo de la Reforma 2620 -11º Piso  
Col. Lomas Altas  
11950 México, D.F.

Model number: BMX01  
Supply voltage: 100 V CA to 240 V CA  
Frequency: 50 Hz/60 Hz  
Current consumption: 16 (x6) A

Model number: DWHH  
Supply voltage: 12 V DC  
Current consumption: 75 A

Model number: FHB  
Supply voltage: 12 V DC  
Current consumption: 75 A

Model number: HHB  
Supply voltage: 12 V DC  
Current consumption: 37 A

Model number: QHB  
Supply voltage: 12 V DC  
Current consumption: 35 A



# Technical Specifications

 **NOTE:** For additional specifications, see your system *Owner's Manual*.

---

## Power — Blades

---

Coin-cell battery	3 V CR2032 Lithium coin cell
-------------------	------------------------------

---

## Power — Enclosure

---

AC/DC power supply (per power supply module)

Wattage	2360 W and 2700 W
Connector	IEC C20
Heat dissipation	1205 BTU/hr (maximum)
Maximum inrush current	Under typical line conditions and over the entire system ambient operating range, the inrush current may reach 55 A per power supply for 10 ms or less.

System Voltage Requirements

43 A, 200 V AC to 240 V AC, 50 Hz/60 Hz (2360 W power supply)

 **NOTE:** This system is also designed to be connected to IT power systems with a phase to phase voltage not exceeding 230 V.

16 A, 100 V AC to 240 V AC, 50 Hz/60 Hz (2700 W power supply)

 **NOTE:** Heat dissipation is calculated using the power supply wattage rating.

---

## Physical — Blades

---

PowerEdge M915

Height	38.5 cm (15.2 inch)
Width	5 cm (2 inch)
Depth	48.6 cm (19.2 inch)
Weight (maximum)	12.7 kg (28 lb)

PowerEdge M910

Height	38.5 cm (15.2 inch)
Width	5 cm (2 inch)
Depth	48.6 cm (19.2 inch)
Weight (maximum)	13.1 kg (29 lb)

PowerEdge M820

Height	38.5 cm (15.2 inch)
Width	5 cm (2 inch)
Depth	48.6 cm (19.2 inch)
Weight (maximum)	14.5 kg (31.9 lb)

---

**Physical — Blades**

---

## PowerEdge M710 and M610x

Height	38.5 cm (15.2 inch)
Width	5 cm (2 inch)
Depth	48.6 cm (19.2 inch)
Weight (maximum)	11.1 kg (24.5 lb)

## PowerEdge M710HD and M620

Height	18.9 cm (7.4 inch)
Width	5 cm (2 inch)
Depth	48.6 cm (19.2 inch)
Weight (maximum)	7.4 kg (16.3 lb)

## PowerEdge M610

Height	18.9 cm (7.4 inch)
Width	5 cm (2 inch)
Depth	48.6 cm (19.2 inch)
Weight (maximum)	5.2 kg to 6.4 kg (11.5 lb to 14.0 lb)

## PowerEdge M520

Height	18.9 cm (7.4 inch)
Width	5 cm (2 inch)
Depth	48.6 cm (19.2 inch)
Weight (maximum)	6.4 kg (14.1 lb)

## PowerEdge M420

## Sleeve

Height	39.5 cm (15.6 inch)
Width	5 cm (2 inch)
Depth	44.3 cm (17.4 inch)
Weight	3 kg (6.61 lb)

## Blade

Height	9.75 cm (3.8 inch)
Width	5 cm (2 inch)
Depth	45.8 cm (18 inch)
Weight (maximum)	2.3 kg (5.07 lb)

---

**Physical — Enclosure**

---

Height	44.0 cm (17.3 inch)
Width	44.7 cm (17.6 inch)

---

**Physical — Enclosure**

---

Depth	75.5 cm (29.7 inch)
Weight (maximum)	200.5 kg (442 lb)
Weight (empty)	44.6 kg (98.1 lb)

---

**Environmental**

---

 **NOTE:** For additional information about environmental measurements for specific system configurations, see [dell.com/environmental\\_datasheets](http://dell.com/environmental_datasheets).

## Temperature

Operating	Continuous operation: 10 °C to 35 °C at 10% to 80% relative humidity (RH), with 26 °C max dew point. De-rate maximum allowable dry bulb temperature at 1 °C per 300 m above 900 m (1 °F per 550 ft).
-----------	--

 **NOTE:** For information on supported expanded operating temperature range and configurations, see [support.dell.com/manuals](http://support.dell.com/manuals).

Storage	–40 °C to 65 °C (–40 °F to 149 °F) with a maximum temperature gradation of 20 °C per hour
---------	---

## Relative humidity

Operating	10% to 80% relative humidity (RH), with 26 °C max dew point
Storage	5% to 95% (noncondensing) at a maximum wet bulb temperature of 38 °C (100.4 °F)

## Maximum vibration

Operating	0.26 G <sub>rms</sub> at 5 Hz to 350 Hz for 15 min
Storage	1.54 G <sub>rms</sub> at 10 Hz to 250 Hz for 15 min

## Maximum shock

Operating	One shock pulse in the positive z axis (one pulse on each side of the system) of 31 G for up to 2.6 ms
Storage	Six consecutively executed shock pulses in the positive and negative x, y, and z axes (one pulse on each side of the system) of 71 G for up to 2 ms

## Altitude

Operating	–15.2 m to 3048 m (–50 ft to 10,000 ft)
-----------	---

 **NOTE:** For altitudes above 2950 ft, the maximum operating temperature is derated 1 °F per 550 ft.

Storage	–15.2 m to 10,668 m (–50 ft to 35,000 ft)
---------	---

## Airborne Contaminant Level

Class	G1 as defined by ISA-S71.04-1985
-------	----------------------------------